

# QUICK START GUIDE

1

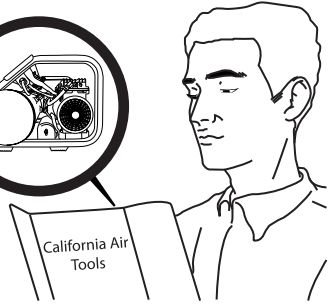
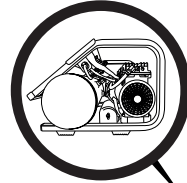
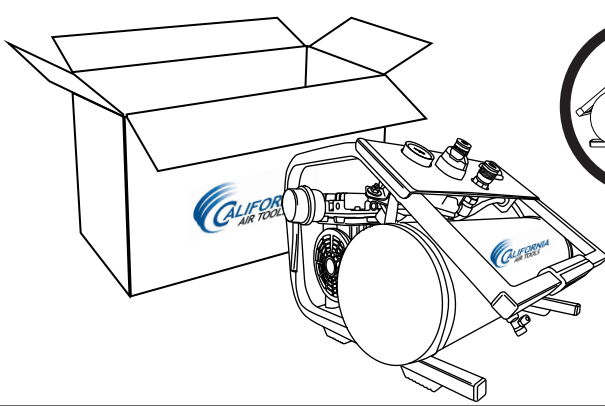

Please Read Manual

2

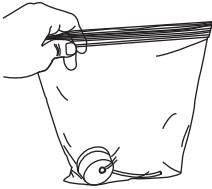

Air Filter Tube Installation

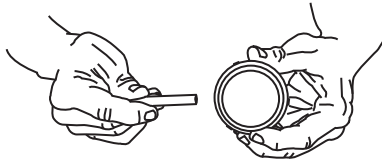

3

Air Filter Installation

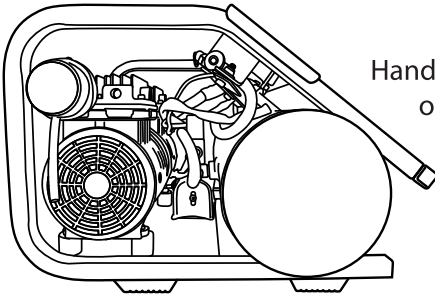

Hand tighten only

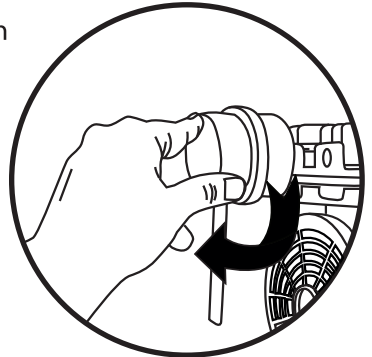

4

1/4" Industrial/ Universal Quick Connect

Push to Connect



## Drain Valve Operation

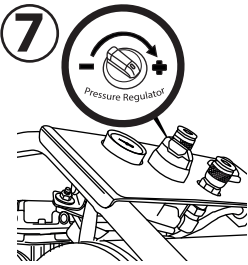
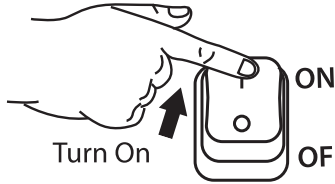
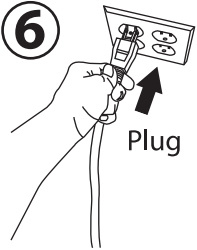
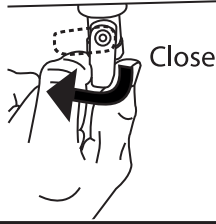
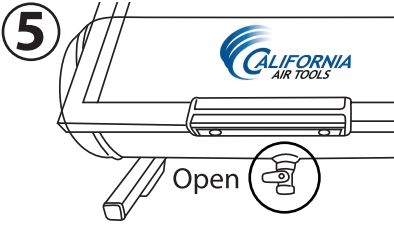

### Pressure Regulator

Turn knob clockwise to rise pressure & counterclockwise to decrease.

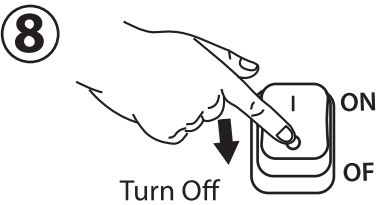
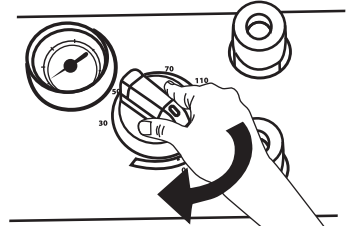

\*Note: Always turn off unit before unplugging

